

VT007 Vibration Plate Exercise Machine

User Manual & Tech Specs

US Version



VT007 User Manual Page Index	
General Info & Warnings 01	Tech Specs, Setup & Use 04
Manual Control & Program07	FAQ 08
Troubleshooting 09	Exploded View 10

Register your VT007 vibration plate at www.vibrationtherapeutic.com/registration



Product registration can facilitate the warranty service process and enable us to reach you for product recalls, upgrades, and safety warnings.



User Manual (US Version)
Vibration Plate Exercise Machine
Model VT007



Linear Vibration
High Frequency – Low Amplitude

Frequency: 10 – 40Hz
Amplitude: 0.7 – 3mm

Versatile ♦ Robust ♦ Reliable ♦ Durable

Vibration Therapeutic® is devoted to making high quality vibration plates for health improvement.

Exceptional Customer Service ♦ Lifetime Support

www.vibrationtherapeutic.com

©Vibration Therapeutic LLC, All Rights Reserved.

Terms, Conditions & Warnings

Message for New Users

New users of the VT007 vibration plate should start with lower frequency, lower amplitude, and shorter exercise time. After adapting to the vibration, you can gradually increase the frequency, switch to high amplitude setting, and extend the exercise time.

Return & Warranty

90-day free return for orders from the 48 contiguous states of the US.

[!] Please keep the machine and the packaging material in good condition for potential return.

10-year product warranty, no out-of-pocket expense for any warranty service for customers in the US.

Customer Service

Please don't hesitate to contact us via www.vibrationtherapeutic.com/service

Customer service is always our pleasure and priority.

Replacement Parts Supply

Replacement parts can be ordered free of charge at www.vibrationtherapeutic.com/parts

We guarantee the supply of replacement parts for at least 15 years after the purchase.

Product Registration

Product registration is convenient at www.vibrationtherapeutic.com/registration

Product registration can facilitate customer services and also allows us to reach you for potential product recalls, updates and safety warnings.

----- Thank You for Choosing Us -----

Disclaimer

We, Vibration Therapeutic LLC, manufacture and sell vibration plates as exercise equipment. If you intend to use this device to treat a medical condition, please consult a medical professional.

We share our studies and experiences regarding the use of our products and vibration therapy in general. However, we are not in the position to provide medical advice for any specific medical condition.

The health benefits suggested or implied in this user manual and on our websites are not approved or endorsed by any regulatory authority or medical institute.

The negative impact of using our products has not been well studied. If you have a serious medical condition, please discuss your intended use of this vibration plate with your doctor.

The use of the VT007 is entirely at the user's discretion.

Please read all instructions in this user manual carefully before using this machine. We assume no responsibility for personal injury or property damage sustained due to the use of this machine.

Scientific Research

Scientific research on vibration therapy has been gaining momentum in recent years.

While most research projects are literature reviews, some limited clinical trials with small sample sizes were conducted to test using vibration plates to treat various medical conditions and achieved some positive results.

However, due to limited resources, none of the clinical trials conducted was adequately designed to test enough variables and their combinations. Many trials were not completed as designed.

Current scientific studies have not led to consistent results to conclude any treatment modality in terms of parameters, procedure, dosage, and efficacy.

Visit our blog website www.vibrationcare.com for our studies and experiences.



Risks, Warnings & Hazards

Excessive exposure to intensive vibration can pose a health hazard. The US Labor Department and the National Institute for Occupational Safety and Health advise caution for the extensive use of vibrational equipment and machinery. However, there is no set of safety standards regulated for vibration exposure.

Normal use of the VT007 vibration plate, for example, a couple of ten-minute sessions a day, would not be considered hazardous.

People with certain medical conditions may not be suitable to use the VT007. These conditions include, but are not limited to, the following.

Pregnancy	Epilepsy	Kidney stones
Implant	Seizures	Bladder stone
Pacemaker	Motion sickness	Acute arthritis
Heart disease	Migraines	Detached retina
Recent surgery		

For general information about risks, warnings and hazards about using vibration plates, please visit

www.vibrationtherapeutic.com/risks

Nausea and Dizziness

Some users can get nausea and dizziness using this machine when vibration is transmitted to their upper body and head.

You can avoid these negative effects by bending your knees or lifting your heels to control the vibration from being transmitted to your upper body and head.

In fact, squat and calf-raise are the best poses for lower limb muscle exercises. They minimize impact to knee joints and reduce vibration transmission to the upper body.

New users should always begin with low vibration intensity and a short session time. Most users can gradually adapt to the vibration and overcome nausea and dizziness.

Safety Instructions

The VT007 vibration plate is intended for indoor use on a flat, dry floor, free from flammable gas or dust.

For users who lack physical strength and balance, we recommend holding onto a wall-mounted handrail or a sturdy piece of furniture.

Never leave the vibration plate running unattended.



Floor Shake & Jump/Drift

[Floor Shake]

VT007 should be used on a solid floor that resists vibration. If used on a wood frame construction floor, the vibration can agitate your floor and the connecting walls, causing damage to your house structure over time.

We suggest you put a large EVA exercise mat beneath the vibration plate to absorb some downward transmitted vibration.

[Jump / Drift]

If there is no body weight on the VT007, vibration can cause the machine to jump / drift on the floor. A carpeted floor can prevent the machine from drifting. You should always keep your body on the vibration plate when it is running.

EMF Exposure

Like all other household electric appliances, the VT007 vibration plate produces electric and magnetic fields (EMF).

According to EPA, there is no definitive scientific evidence demonstrating that electromagnetic fields (EMF) have an impact on health. The EPA does not establish specific levels designating EMF exposure as either safe or hazardous.

Visit our website for the EMF measurement results of the VT007 and comparisons with other common household electric appliances.

Vibration Noises

The VT007 generates mechanical and soundwave noise. The noise level increases with higher vibration frequencies.

Excessive or high-pitched mechanical noise indicates defective parts or assembly error.

Visit our website for the noise measurement results of the VT007 and comparisons with other common household electric appliances.



Recommended Exercises

We highly recommend performing the following core strength physical exercises on the VT007.

Exercise	Muscle Trained
Squat	Muscles around knees
L-Squat	Muscles around hips
Deadlift	Lower back muscles
Calf-raises	Calf muscles
Tiptoeing	Foot muscles
V-sit	Abdominal muscles
Push-ups	Chest, triceps and shoulder

To better understand how vibration stimulation can enhance these exercises, please visit

www.vibrationtherapeutic.com/vibration-exercise.html



Join our discussions about vibration therapy on our blog site: www.vibrationcare.com.

Tech Specs, Setup & Use

VT007 Unboxing

Inside the box of the VT007 are the following items:

- 1) VT007 vibration unit
- 2) VT007 control console
- 3) Power cord
- 4) Remote control
- 5) A pair of inelastic balance straps
- 6) This user manual



Tech Specifications

Type of Vibration	Linear Vibration
Frequency Range	10 – 40 Hz Adjustable
Amplitude @ Hi	1.5 - 3 mm without load
Amplitude @ Lo	0.7 -1.2 mm without load
Power Supply	AC 110V – 240V, 50/60Hz
Electric Motor	PMDC motor 120V 80W
Machine Dimensions	560 x 420 x 145 mm 22 x 16.5 x 5.7 inches
Machine Weight	10.4 KG / 23 LB
Max User Weight	140 KG / 308 LB

Connect the Control Box

The VT007 is designed with a separated plug-in type control console.



Connecting the control console to the vibration unit:

- 1) Locate the key on the plug and the keyhole on the socket.
- 2) Match the key with the keyhole and then push the plug into the socket.
- 3) Once the plug is fully pushed into the socket, screw the plug cap onto the socket.

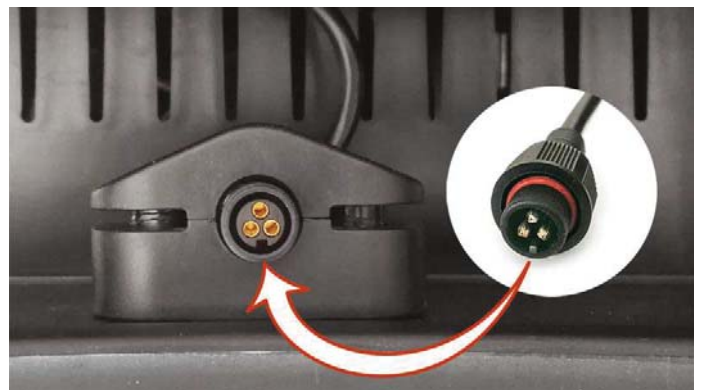

Match the key with the keyhole

Once the control console is connected to the vibration unit, you can now plug in the power cord and connect the control console to your home AC supply.

The power switch is located at the front side of the control console, next to the AC power socket.

Default Settings

When the VT007 is powered on, the default settings are as below:

- Manual control mode – P0
- Vibration frequency: 15Hz
- Amplitude: Lo (Low)
- Session time: 10 minutes



Quick Start Guide

When the VT007 is powered on, the control console digit-displays light up. You can then control the machine from either the control console or remote control.

You can start using your VT007 by pressing the Start button to run vibration with the default settings.

For beginners, we highly recommended starting with the default settings and short exercise time. **

Once you are adapted to the vibration, you can gradually increase the frequency, switch to Hi amplitude setting, and extend the exercise time.

VT007 has adjustable frequency from 10 to 40Hz, and two amplitude settings (Hi and Lo).

To use the program control mode, you can use P button to select program mode P1, P2 or P3 when the machine is idle.

Always keep your body on the vibration plate when it is running.

Bend you knees or lift your heels on the VT007.

Adjust your position to minimize vibration noise.

** If the default frequency of 15Hz is still too high for you, you may lower it down to 10Hz.





This allows you to progressively build your physical strength to endure higher frequencies.

Control Panel









Control Panel Digit-Displays and Indicators

Hz / Program Display (left side)	When VT007 is powered on but idle, It displays operation mode. You can select either manual mode (P0) or programmed mode (P1, P2 or P3).
	When VT007 is vibrating, it displays vibration frequency in Hz.
Session Time Display (right side)	When VT007 is powered on but idle, it displays session time in minutes.
	When VT007 is vibrating, it displays the remaining minutes of the running session.
Green Light	Indicating the machine is on low amplitude setting.
Red Light	Indicating the machine is on high amplitude setting.
Remote Receiver	IR signal receiving sensor for remote control.

Control Panel Buttons	
Button	Function
 Time/Hz	When VT007 is powered on but idle, press this button to increase vibration session time.
	When VT007 is vibrating on manual mode, press this button to increase vibration frequency.
	This button is disabled in program mode.
 Time/Hz	When VT007 is powered on but idle, press this button to decrease vibration session time.
	When the VT007 is vibrating on manual mode, press this button to decrease vibration frequency.
	This button is disabled in program mode.
	Start / Stop button
	Selects between manual mode (P0) and program mode (P1, P2 or P3).
	Switch vibration amplitude settings between Hi and Lo. This button is disabled in program mode.



Remote Control Buttons	
Button	Function
	Set desired session time when VT007 is powered on and idle. The default session time is 10 minutes.
	Time buttons are disabled when VT007 is vibrating.
	Adjusts the frequency when the machine is running on manual mode.
	Hz buttons are disabled in program mode.
	Start / Stop button
	Selects between manual mode (P0) and program mode (P1, P2 or P3).
	Switch vibration amplitude settings between Hi and Lo. This button is disabled in program mode.

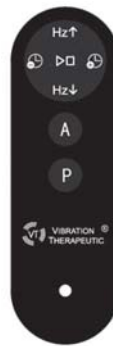

The remote control is an infra-red type. It must be pointed to the remote receiver sensor on the control box to work.

For the first use, please remove the battery insulation sheet inserted at the right side of the remote control.

Battery Type: CR2032 or CR2025

In the following situations, some control buttons are logically DISABLED:

1. Session time buttons and program buttons are disabled when the machine is vibrating.
2. All buttons except for the Stop button are disabled when the machine is running on program mode.

Manual Control & Program

You can use manual control or program to get your desired vibration frequency and amplitude.

Mode	Amplitude	Suggested Applications
P0	Manual	Custom
P1	Lo	Relax exercise
P2	Hi	Cardio exercise
P3	Lo / Hi	Mixed exercise

Manual Mode

In manual control mode (P0), prior to initiating vibration, you have the option to set the exercise session timer between 1 and 20 minutes. The default session time is 10 minutes.

You can adjust the vibration frequency only when the machine is running. The default frequency 15Hz.

You can switch the amplitude setting between Hi and Lo at anytime.

For beginners, we highly recommend starting with the default settings and shorter exercise time.

If the default frequency of 15Hz is too high for you, you may lower the frequency down to 10Hz.

Program Mode

In program mode (P1, P2, or P3), the frequency and amplitude are pre-programmed to change in a specific pattern during a 10-minute session. All buttons, except for the Start/Stop button, are disabled.

The purpose of program modes is to generate a range of patterns and levels of stimulation by varying the frequency and amplitude.

If you find it challenging to endure your desired frequency initially, consider using a program mode to ease in, gradually progressing to a higher frequency.

The charts below illustrate the frequency changes and amplitude switches for each program mode. In P3 mode, amplitude switching is incorporated alongside frequency changes.

In these charts, each dot represents a 5-second period of vibration at a specific frequency. Green dots indicate a low amplitude setting, while red dots indicate a high amplitude setting.

Frequency & Amplitude Charts of Program Modes

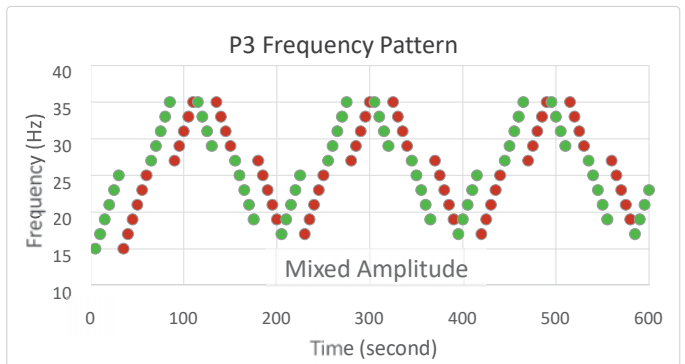
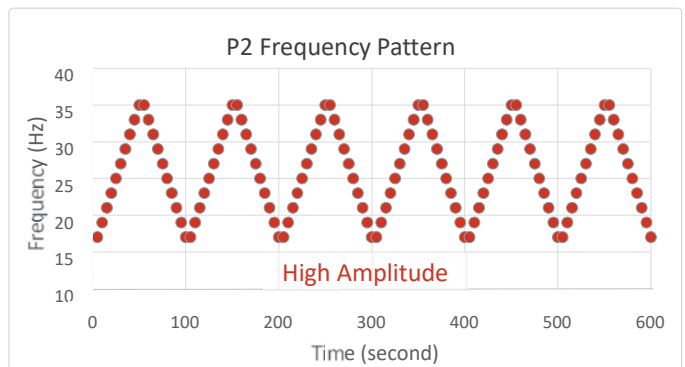
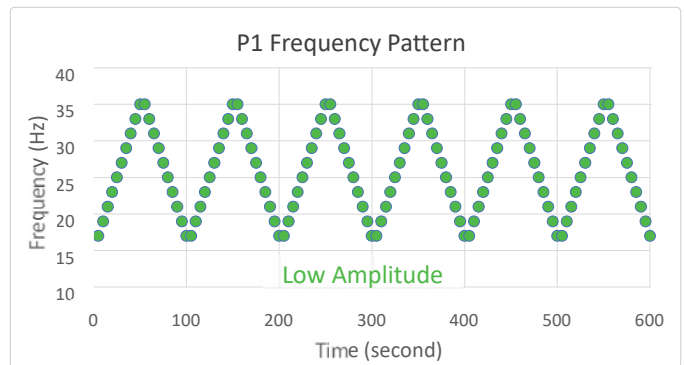

FAQ

Clunk Sound

The clunk sound you hear when you activate vibration and switch amplitude is a normal occurrence.

You can also hear this clunk sound in program P3 as the amplitude setting is switched between Hi and Lo multiple times in this mode.

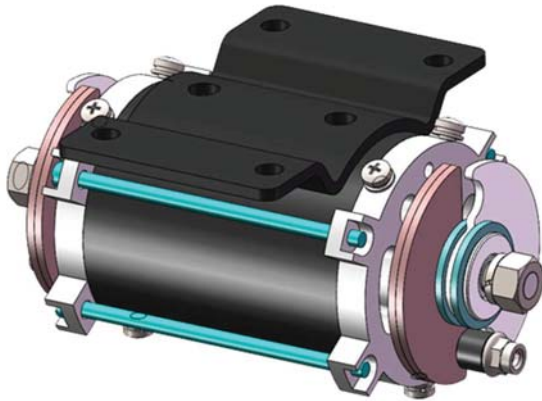

The VT007 switches amplitude by reversing motor rotation direction to reposition the eccentric wheels. The clunk sound is produced when the eccentric wheels reverse and strike the position block.

There is also a short grinding sound, which is from the friction between eccentric wheels when they rotate to the position.

The clunk and grinding sounds are not an issue. They don't harm the machine.



Recommended Exercise: Foot Muscle Training



- Balance & Mobility
- Circulation
- Injury Prevention
- Deformity Prevention

Tiptoe on vibration plate, the most effective foot muscle training.



Visit www.vibrationcare.com for its benefits and tips.

Vibration Intensity Center

At the Hi amplitude setting, the vibration intensity center is towards the control box side.

At the Lo amplitude setting, the vibration intensity center is away from the control box side.



The shift of the intensity center is because of the motor rotation reverse designed for two amplitude settings.

You should align your body weight right on the intensity center to get the best performance from the VT007 and avoid excessive vibration noise.

Replacing the Fuse

The fuse box is next to the power switch. Use a screwdriver to pry it out.



The fuse is a 5 amp glass tube fuse, length 20mm, diameter 5mm, available from most hardware stores.

VT007 Troubleshooting

Issue	Possible Cause	Solution / Action
Machine powered on, but the control console display not lit up. Or, The power connection is not stable.	Power cord NOT fully plugged in the control box.	Forcefully push the power cord plug into the socket of the control console.
	Control console fuse burned.	Replace the fuse.
	Defective control console	Contact the seller for a replacement.
Machine powered on, control panel lit on, but does not vibrate when the Start button is pressed.	Control console is not properly connected to the vibration unit.	Check the connector. The plug key needs to match the socket keyhole.
	Defective control console or motor.	Contact the seller for a replacement.
Remote control does not work.	Remote control not pointed to the signal receiving sensor on the control console.	Point the remote control to the remote receiving sensor.
	Remote control out of battery.	Replace the battery (CR2032).
	Defective remote control.	Order a replacement remote control, free of charge.
Machine does not respond to any button, runs on the highest speed.	Control console malfunction.	Contact the seller for a replacement control console.
Excessive noise	Power cord touching the vibration unit.	Rearrange the power cord.
	Accessories or alien objects left between the upper board and the lower board.	Remove the accessory or alien object.
	User's body weight is not centered on the vibration center.	Find the right standing spot with the least noise.
	High pitch noise.	Contact the seller.
	The 4 socket-cap screws above the rubber springs become loose over time.	Tighten the socket-cap screws moderately.

Order VT replacement parts for free at www.vibrationtherapeutic.com/parts



Design Patent
ZL2020-3-0093839.0

User-Serviceable

VT007 vibration plate is user-serviceable because of its industrial design. The machine can be disassembled using just a screwdriver and two hex wrenches. We guarantee the supply of replacement parts for at least 15 years after the purchase.

For VT007 repair please visit www.vibrationtherapeutic.com/VT007-repair.

Company Website

www.vibrationtherapeutic.com



Product Registration

www.vibrationtherapeutic.com/registration



Please share

your experiences.



Studies & Experiences

www.vibrationcare.com



Get Connected

www.facebook.com/vibrationtherapeutic

